

# OWNERS MANUAL

MANUAL NO. 659773

8/3/04

# KOYKER<sup>®</sup>

## 645 LOADER GRAPPLE FORK

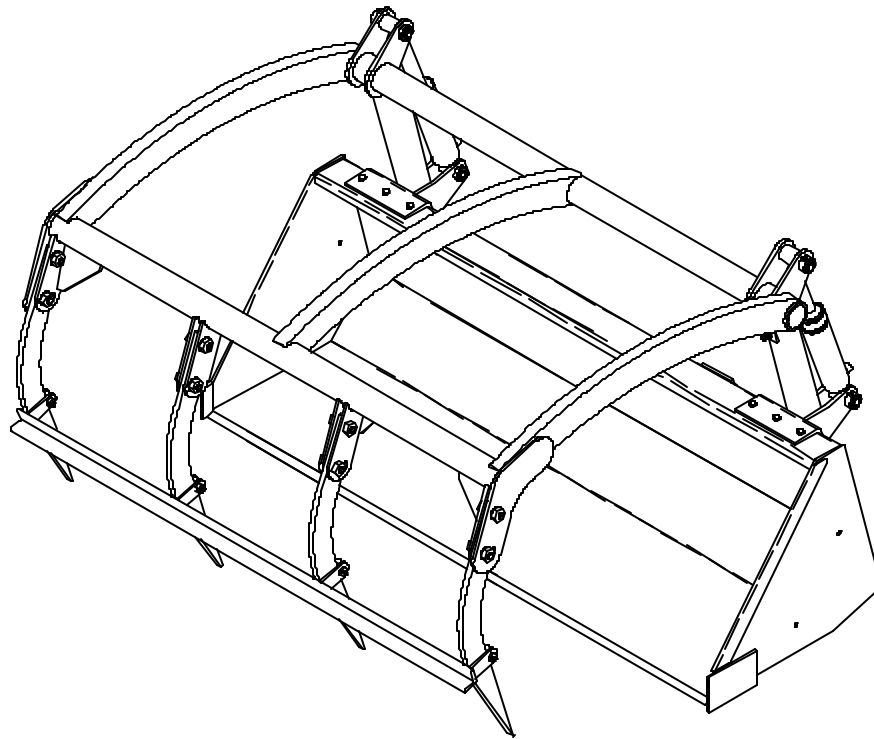

**IMPORTANT – KOYKER DEALER  
BE SURE THIS MANUAL IS GIVEN TO THE  
PURCHASER FOR FUTURE REFERENCE  
KOYKER MANUFACTURING CO., P.O. BOX 409  
LENNOX, SD 57039**

Phone 1-800-456-1107 E-mail [koyker@koykermfg.com](mailto:koyker@koykermfg.com)

# CONTENTS

| <b>CONTENTS</b>  | <b>PAGE</b> |
|--|-------------|
| Introduction.....                                      | 1           |
| <b>SAFETY INFORMATION</b>                              |             |
| Safety Alert Symbol.....                               | 2           |
| Safety Information.....                                | 3-5         |
| Safety Decals.....                                     | 6           |
| <b>ASSEMBLY INSTRUCTIONS</b>                           |             |
| Hydraulic Installation Instructions.....               | 7           |
| Grapple Fork Installation Instructions.....            | 8           |
| <b>OPERATING INSTRUCTIONS</b>                          |             |
| Operation.....   | 9           |
| <b>SERVICE AND MAINTENANCE</b>                         |             |
| Grapple Fork Inspection, Service, and Maintenance..... | 10          |
| Hydraulic System Parts Schedule.....                   | 11          |
| Hydraulic System Parts Diagram.....                    | 12          |
| “645” Grapple Fork Parts Diagram.....                  | 13          |
| Grapple Fork Parts Schedule.....                       | 14-15       |
| Cylinder Information.....                              | 16          |
| 3” Cylinder Service Kit.....                           | 17          |
| Hydraulic Cylinder Parts Schedule.....                 | 18          |
| Hydraulic Cylinder Parts Diagram.....                  | 19          |
| Piston and Gland Service Diagram.....                  | 20          |
| <b>LIMITED WARRANTY INFORMATION</b>                    |             |
| Limited Warranty.....                                  | 21-23       |

## INTRODUCTION

For years, Koyker Manufacturing Company of Lennox, South Dakota, has provided the farm loader industry with innovative ideas for a more efficient and dependable means of material handling. Now, with the increasing popularity of the MFWD (Mechanical Front Wheel Drive) tractors, Koyker has again met the challenge and provided the market with loaders and attachments that will allow the efficient use of these tractors in material handling. The KOYKER Grapple Fork provides you with state-of-the-art design and innovation for your material handling chores.

Features such as quality construction, ease of maintenance, and high performance operating capacities, all at a low price, make the Grapple Fork one of the most efficient loaders ever. With proper care and handling, it will provide many years of dependable service.

This manual is designed to provide you with important information regarding the Grapple Fork. Our sincere intent, in providing this manual, is to help you or those involved better understand the machine and to prevent accidents.

Should you have any questions, comments, improvements, or suggestions regarding the contents of any of the manuals provided, please contact Koyker Manufacturing Company (800-456-1107 or E-mail [koyker@koyker mfg.com](mailto:koyker@koyker mfg.com)).

**We care about your safety!**

**Remember ALL safety decals are no charge from the factory. Please replace all safety decals if missing or damaged. Your safety is important to us.**

## SAFETY ALERT SYMBOL

The symbol shown below is used to call your attention to instructions concerning your personal safety. Watch for this symbol it points out important safety precautions. It means **ATTENTION! Become Alert! Your Personal Safety Is Involved!**

Read the message that follows and be alert to the possibility of personal injury or death.

**DANGER:** Indicates an imminently hazardous situation that, if not avoided, will result in death or serious injury.

**WARNING:** Indicates a potentially hazardous situation that, if not avoided, could result in death or serious injury.

**CAUTION:** Indicates a potentially hazardous situation that, if not avoided may result in minor or moderate injury.



**WARNING!**

Anyone who will operate or work around a front-end loader should first read this manual.

# SAFETY

Improper use of a loader can cause serious injury or death. The following safety precautions, and those given on the tractor mount installation instructions, should be thoroughly understood before attempting to operate this machine.

## **BEFORE OPERATING:**

Carefully study and understand this manual, the specific tractor mount instructions, and the attachment(s) manual(s).

Prior to operation, inspect the loader for system leaks and damaged, missing, or malfunctioning components in an effort to avoid the possibility of a dangerous failure involving structural members or hydraulic system components.

Be certain any repairs necessary are completed prior to loader operation.

Follow recommended maintenance procedures and precautions on Page 10

Completely familiarize yourself and others involved with the operation of the hydraulic control valve before operating the loader.

Be certain all bystanders are clear of the machine and operation area prior to operation.

It may be necessary to add wheel ballast or rear weights as recommended by the tractor manufacturer to maintain stability of the machine to prevent tipping or upset which could result in serious injury or death. See mounting instructions for specific information.

It is recommended that both front and rear wheel treads be set to the widest recommended width to prevent tipping or upset which could result in serious injury or death.

This loader is designed for farm type operations such as snow removal, barn and feedlot cleaning or light grading and digging. It's design is **NOT** intended for commercial and/or industrial use.

## **DURING OPERATION:**

Never operate the machine other than from the tractor operator's seat.

Be sure operating area is clear of others during machine operations.

Never lift, hoist, or carry humans in the bucket or on any portion of the loader or loader attachments. Failure to heed, may result in serious injury or death.

## **SAFETY CONTINUED**

Transport the machine load at the slowest speed possible and with the loader boom at the lowest transport position to avoid tipping or upsetting, which may result in serious injury or death.

Be extremely careful when working on inclines or near loose fill, rocks, and holes as they can cause tipping or upsetting which may result in serious injury or death.

Be certain to avoid overhead electrical wires when operating loader. Contact with power lines may cause serious injury or death.

Avoid sudden stops when lowering or lifting the loader boom to prevent loss of control over the machine and/or load, which may result in serious injury or death.

Use maximum ballast and the widest recommended wheel setting on your tractor when handling large shiftable loads.

Never attempt to ram with the bucket at high speed or full tractor power. Sudden impact may result in structural failure and possible serious injury or death.

Never adjust or perform maintenance on the loader or tractor with the unit in motion, or without power source locked out.

Never get under bucket or lift arms or reach through the lift arms or bucket linkage when the loader is in operation. Inadvertent movement may cause serious injury or death.

### **FOLLOWING OPERATION:**

Whenever the machine is not in operation, lower the loader boom and set the tractor brakes, disengage drive, shut the engine off, and remove the ignition key before dismounting the tractor.

If loader is to be disengaged from tractor, be sure the loader is securely supported on a hard, level surface and the stand is securely engaged. Be certain all connections between tractor and loader are free before disengaging.

### **TRANSPORTING:**

Use safety lights and SMV emblem in addition to whatever local codes require when equipment is being transported on the road or highway. Check with proper authorities for legal limitations.

Transport all loads at a slow and safe speed.

Carry the load as low as possible and maintain adequate visibility and good round clearance at all times.

## SAFETY CONTINUED

### PERFORMING MAINTENANCE:

Carefully review, understand, and follow the “maintenance” section in this owners manual before attempting to service loader.

Lower the bucket or attachment to the ground, shut off tractor engine, and relieve pressure in the hydraulic system before adjusting, lubricating, or servicing the loader.

Escaping hydraulic oil under pressure can penetrate the skin. Never use any part of your body to check for hydraulic leaks. Use cardboard when checking for leaks. See Fig. 5-1. Relieve hydraulic pressure before disconnecting any hydraulic line. Failure to heed may result in serious injury or death.

Before disconnecting hydraulic lines, lower the loader and attachments. Lock out the hydraulic supply and relieve all hydraulic pressure.

### REMEMBER:

1. Move Slowly!
2. Always use care and common sense!
3. Be careful for your own sake and for that of others!

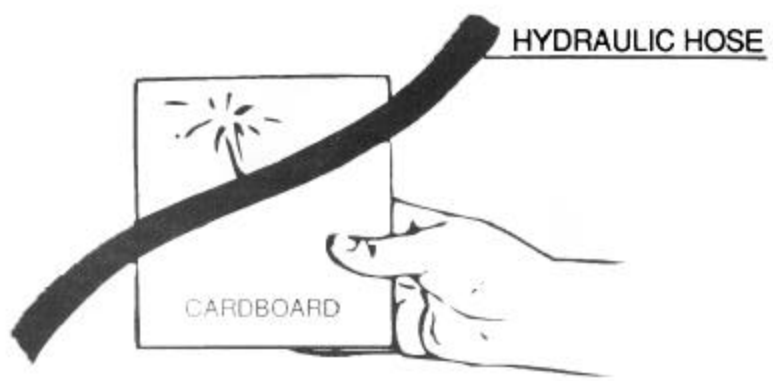
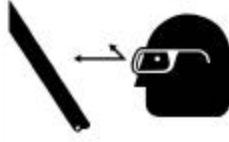



FIG. 5-1

# SAFETY DECALS

|   |  |
|---|--|
|  | <b>⚠ WARNING</b>   |
|  | <b>HIGH-PRESSURE FLUID HAZARD</b><br>To prevent serious injury or death: <ul style="list-style-type: none"><li>• Relieve pressure on hydraulic system before servicing or disconnecting hoses.</li><li>• Wear proper hand and eye protection when searching for leaks. Use wood or cardboard instead of hands.</li><li>• Keep all components in good repair.</li><li>• Refer to owners manual if injury should occur.</li></ul> <p style="text-align: right;">666943</p> |

|   |
|---|
| <b>⚠ WARNING</b>  |
|    |
| <p>To help prevent bodily injury</p> <ul style="list-style-type: none"><li>• Park and store grapple fork in closed position.</li><li>• Do not work from or allow riders on loader or its attachments.</li><li>• Stay clear of grapple fork while in use.</li><li>• Keep all none operators away from grapple fork during use.</li><li>• Avoid pinch points.</li><li>• Stay clear of grapple teeth.</li><li>• read operators manual</li><li>• Do not handle bales that exceed bale weight of 900 Kg (2000 lb).</li></ul> <p><b>KOYKER MFG CO. INCLUDES ALL REASONABLE MEANS FOR ACCIDENT PREVENTION EXCEPT A SAFE AND CAREFUL OPERATOR.</b></p> <p style="text-align: right;">666942</p> |

# HYDRAULICS INSTALLATION INSTRUCTIONS

## INSTALLATION NOTES:

- Install all parts with appropriate fasteners "finger tight" before tightening any bolt.

## DIRECTIONS:

1. Install the cylinders by attaching the cylinder tube terminal to the bottom bracket of the mast with a pivot pin, and 5/16" x 2 1/4" HH capscrew and locknut. Note: Make sure the ports on the cylinder are positioned away from the grapple mast. Then pull the rod terminal out of the cylinder and attach to the main frame with a pivot pin, and 5/16" x 2 1/4" HH capscrew and locknut.
2. Install two 1/4" x 2 1/2" studs into the oil line holders on the back of the bucket. Then place the two grapple fork oil lines to the back of the bucket. Attach the oil lines to the bucket with two oil line insulators, four oil line clamps and two 1/4" hexnuts. After that attach the grapple line cover followed by two 1/4" locknuts.
3. Remove the existing oil line cover that is on the main frame of the loader, and replace with the oil line cover that came with the kit. Reuse the existing hardware to fasten.
4. Next install the 1st and 2nd grapple fork oil lines to the right-hand side of the loader main frame just above the existing lines with four oil line insulators, four oil line clamps, two 1/4" x 1 1/4" socket head screws and two 1/4" locknuts. See fig. 7-1. Note: Adjust the oil lines so that they are properly staked on the main frame.
5. Attach the bottom portion of the oil lines to the oil line cover by using one oil line insulator, two oil line clamps, one 1/4" x 1 1/4" socket head screw and one 1/4" locknut.
6. Then install the two quick coupler sets to the ends of the grapple fork oil lines on the loader. Note: A good thread sealant is recommended for use on all pipe thread to prevent fluid leakage. Next attach the two 60" hoses from the quick couplers to the oil lines on the back of the bucket. Use the two pieces of hose wrap provided to secure the hoses together. Finally remove the port plugs from the cylinder ports, and install the four 22" hoses from the cylinder to the ends of the oil lines. (See the hydraulic schematic for proper connections.) Installation is now complete.

Fig. 7-1

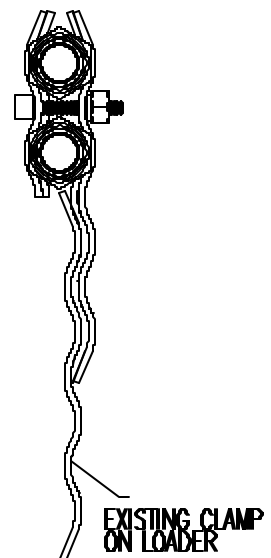

# GRAPPLE FORK INSTALLATION INSTRUCTIONS

## INSTALLATION NOTES:

- Install all parts with appropriate fasteners "finger tight" before tightening any bolt.
- This grapple fork will only fit on 7' or 8' fast attach buckets.

## DIRECTIONS:

1. Attach the grapple masts to the back of the bucket by drilling six 9/16" diameter holes in the top of the bucket. (Note: If your grapple fork was purchased with a bucket the holes are pre-drilled in the top of the bucket.) **IMPORTANT!** Make sure that the grapple masts are aligned properly with the back of the bucket, and the masts are properly spaced for the main frame to attach. Then fasten the bottom of the masts to the bucket with four 5/8" x 2" HH carriage bolts, lockwashers and hexnuts. NOTE: You may or may not require 1/4" spacer plates between the bucket and bottom of masts. Then attach the reinforcement plate to the bottom of the top lip of the bucket along with the top of the masts with six 1/2" x 3 1/2" HH capscrews, lockwashers and hexnuts.
2. Install the main frame to the grapple masts by sliding the frame strap between the cylinder mount and fasten to the grapple mast with four 1/2" x 5 1/2" HH capscrews, lockwashers and hexnuts.
3. Attach the four grapple fork teeth to the main frame with eight 3/4" x 2" HH capscrews, lockwashers and hexnuts. Note: If you have bucket teeth, the teeth will have to be attached in the outermost hole set. See (Fig. 8-1)

FIG. 8-1



BUCKET TEETH

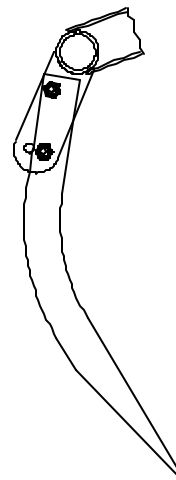

TOOTH POSITION WITHOUT  
BUCKET TEETH

## OPERATION



### **WARNING:**

Never allow anyone to operate the Grapple Fork until they have carefully reviewed and understood this owner's manual.

### **OPERATING THE GRAPPLE FORK:**

With the forks fully opened, approach and enter the pile slowly.

Adjust attachment tilt as necessary.

After entering the pile, slowly close the grapple and roll attachment back.

Raise loader only enough to permit maneuvering.

Before moving, carefully check for hazards and/or obstructions.

Never lift off center.



### **WARNING:**

Be certain material cannot fall or spill out on tractor when raised. Keep clear of overhead obstructions such as trees, limbs, or power lines when raising the loader and grapple fork.

Never lift higher than required. Travel with load at lowest position.

**NEVER** attempt to operate the loader or grapple fork with unauthorized or persons near.

untrained

## INSPECTION, SERVICE, AND MAINTENANCE

Lower the bucket to the ground, shut off tractor engine, and relieve the pressure in the hydraulic system before adjusting, lubricating, or servicing the loader.

Inspect all pins and grease fittings before each use and lubricate with heavy duty grease as indicated in this manual.

Periodically check all bolts for looseness and retorque if necessary.

Before storage, be certain all hydraulic cylinders are fully collapsed so that the rod will not be exposed to the elements or damaged.

Be certain hydraulic system remains sealed at all times to prevent contamination.

Check and maintain an adequate fluid level in the tractor reservoir prior to use.

Inspect all hydraulic system hoses and fittings. Replace prior to further operation if damaged.



### WARNING!

Escaping hydraulic oil under pressure can penetrate the skin. Never use any part of your body to check for hydraulic leaks. Use cardboard when checking for leaks. See Fig. 10-1. Relieve hydraulic pressure before disconnecting any hydraulic line. Failure to heed may result in serious injury or death.

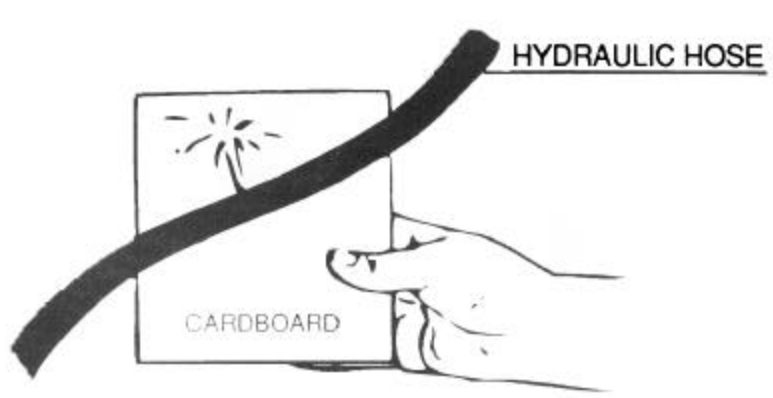
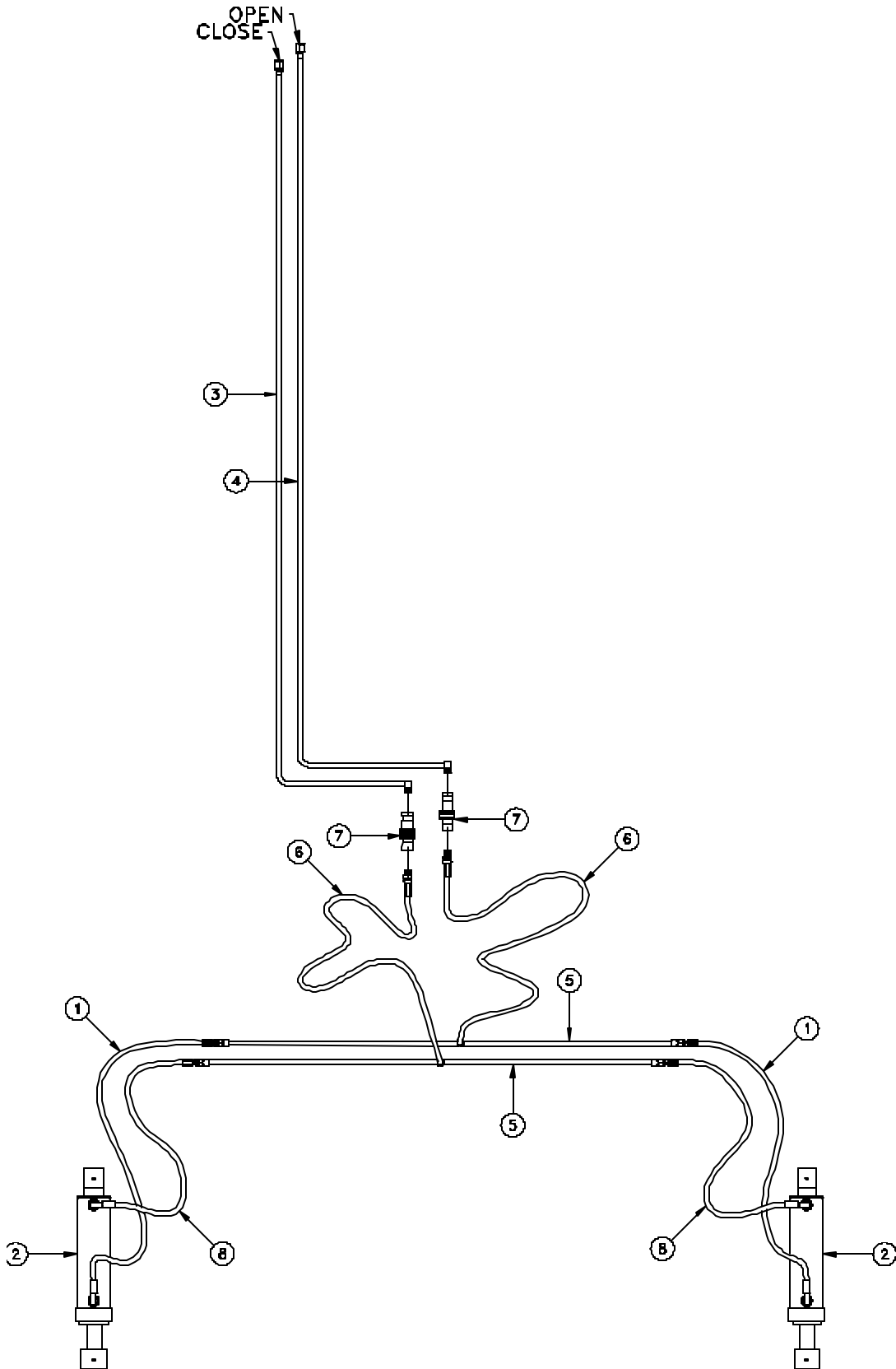

FIG. 10-1

## HYDRAULIC SYSTEM PARTS SCHEDULE

| KEY    | PART NUMBER | DESCRIPTION                       | QUANTITY |
|--------|-------------|-----------------------------------|----------|
| 1..... | 658589..... | 18" Hydraulic Hose.....           | 2        |
| 2..... | 672451..... | 3" Cylinder .....                 | 2        |
| 3..... | 659763..... | 1st Grapple Fork Oil Line .....   | 1        |
| 4..... | 659764..... | 2nd Grapple Fork Oil Line.....    | 1        |
| 5..... | 659771..... | Grapple Fork Oil Line.....        | 2        |
| 6..... | 660093..... | 66" Hydraulic Hose.....           | 2        |
| 7..... | 641758..... | Quick Coupler Set; 1/2" NPT ..... | 2        |
| 8..... | 670518..... | 20" Hydraulic Hose.....           | 2        |

# HYDRAULIC SYSTEM PARTS DIAGRAM



# KOYKER "645" GRAPPLE FORK PARTS DIAGRAM

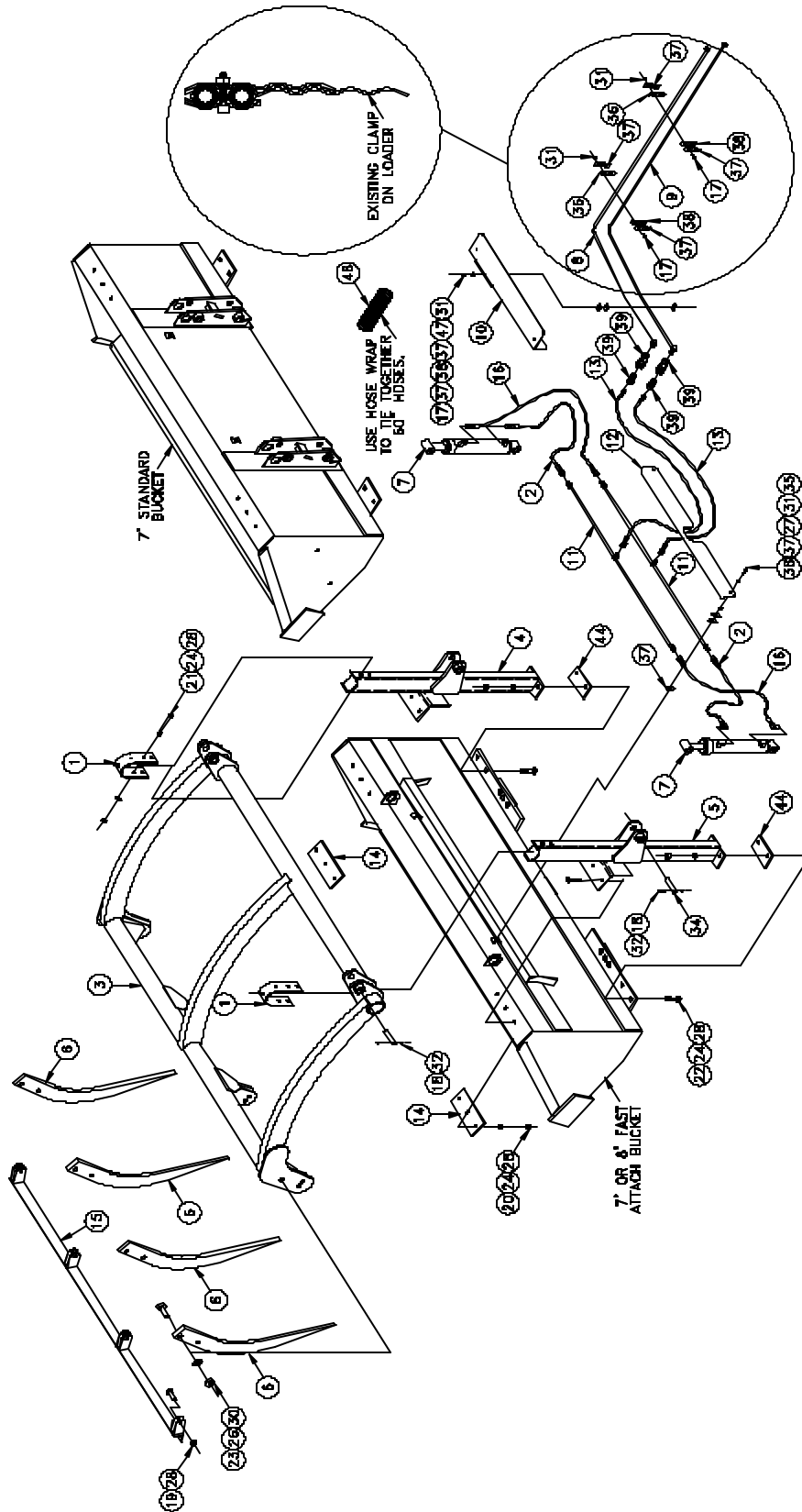

## GRAPPLE FORK PARTS LIST

| KEY | PART NUMBER | DESCRIPTION                              | QUANTITY |
|-----|-------------|--|----------|
| 1   | 661569      | Frame Strap                              | 2        |
| 2   | 658589      | 18" Hydraulic Hose                       | 2        |
| 3   | 668814      | Main Frame                               | 1        |
| 4   | 665800      | RH Grapple Mast                          | 1        |
| 5   | 665801      | LH Grapple Mast                          | 1        |
| 6   | 657338      | Grapple Fork Tooth                       | 4        |
| 7   | 672451      | 3" Cylinder                              | 2        |
| 8   | 659763      | 1st Grapple Fork Oil Line                | 1        |
| 9   | 659764      | 2nd Grapple Fork Oil Line                | 1        |
| 10  | 659770      | Oil Line Cover                           | 1        |
| 11  | 659771      | Grapple Fork Oil Line                    | 2        |
| 12  | 659772      | Grapple Line Cover                       | 1        |
| 13  | 660093      | 66" Hydraulic Hose                       | 2        |
| 14  | 658139      | Reinforcement Plate                      | 2        |
| 15  | 668956      | Grapple Fork Tooth Reinforcement Bracket | 1        |
| 16  | 670518      | 20" Hydraulic Hose                       | 2        |

## GRAPPLE FORK PARTS LIST

| KEY     | PART NUMBER | DESCRIPTION                            | QUANTITY |
|---------|-------------|--|----------|
|         | #721        | Hardware Bag                           | 1        |
| 17..... | 661581..... | Socket Head Screw; 1/4" x 1 1/4" ..... | 3        |
| 18..... | 640021..... | HH Cap Screw; 5/16" x 2 1/4" .....     | 4        |
| 19..... | 640061..... | HH Cap Screw; 1/2" x 2" .....          | 4        |
| 20..... | 640066..... | HH Cap Screw; 1/2" x 3" .....          | 6        |
| 21..... | 640071..... | HH Cap Screw; 1/2" x 5 1/2" .....      | 4        |
| 22..... | 640080..... | Carriage Bolt; 5/8" x 2" .....         | 4        |
| 23..... | 640980..... | HH Cap Screw; 3/4" x 2 1/2" .....      | 8        |
| 24..... | 640157..... | Lockwasher; 1/2" .....                 | 14       |
| 25..... | 640159..... | Lockwasher; 5/8" .....                 | 4        |
| 26..... | 640162..... | Lockwasher; 3/4" .....                 | 8        |
| 27..... | 640127..... | Hexnut; 1/4" .....                     | 4        |
| 28..... | 640139..... | Hexnut; 1/2" .....                     | 14       |
| 29..... | 640142..... | Hexnut; 5/8" .....                     | 4        |
| 30..... | 640146..... | Hexnut; 3/4" .....                     | 8        |
| 31..... | 640126..... | Locknut; 1/4" .....                    | 5        |
| 32..... | 640128..... | Locknut; 5/16" .....                   | 4        |
| 33..... | 657199..... | Pivot Pin .....                        | 2        |
| 34..... | 660369..... | Pivot Pin .....                        | 2        |
| 35..... | 655181..... | Stud; 1/4" x 2 1/2" .....              | 4        |
| 36..... | 661030..... | Oil Line Clamp .....                   | 2        |
| 37..... | 660194..... | Oil Line Clamp .....                   | 8        |
| 38..... | 661016..... | Oil Insulator .....                    | 5        |
| 39..... | 641758..... | Quick Coupler Set; 1/2" NPT .....      | 2        |
| 40..... | 673964..... | Colored Coupler Plug (Black) .....     | 1        |
| 41..... | 673962..... | Colored Coupler Plug (Orange) .....    | 1        |
| 42..... | 666943..... | Warning Decal .....                    | 2        |
| 43..... | 666942..... | Warning Decal .....                    | 1        |
| 44..... | 660836..... | Spacer .....                           | 2        |
| 45..... | 657632..... | Grease Zerk .....                      | 4        |
| 46..... | 659674..... | 24" Hose Wrap .....                    | 2        |
| 47..... | 640150..... | Flatwasher; 1/4" .....                 | 3        |

## CYLINDERS

**IMPORTANT: Read these service tips before beginning assembly of cylinder gland or piston.**

1. Keep seals clean from the time they are removed from package until they are installed.
2. Clean the groove or bore into which the seal is to be fitted before installing the seal.
3. Never touch the seal lip in handling. Always pick up the seal by its outer member.
4. Inspect each seal lip carefully for nicks, scratches, and dirt at time of installation. If dirty use a soft, clean cloth and carefully wipe off seal. **DO NOT wipe seal with fingers, this only imbeds dirt in the seal.**



**NEVER clean rubber related seals with a mineral based solvent! Clean rubber seals in denatured alcohol or non-mineral based solvents only.**

NOTE: Seals can be made more pliable and easier to install, if first heated in hydraulic oil to 160°F. Never use direct heat on any seals.

## 3" CYLINDER SERVICE KITS WITH 1 1/2" SHAFT

### **KIT NO. 662049:**

Complete kit with all seals needed to service one (1) 3" Cylinder. Consists of:

|        |                       |
|--------|-----------------------|
| 1 each | 3" Gland "O" Ring     |
| 1 each | 3" Backup Ring        |
| 1 each | 1 1/2" U-Cup Rod Seal |
| 1 each | 1 1/2" Rod Wiper      |
| 2 each | 3" U-Cup Piston Seal  |
| 1 each | 1" Rod "O" Ring       |
| 1 each | 1" Locknut            |

### **KIT NO. 663339:**

Complete assembled 3" Cylinder Gland with all seals. Consists of:

|        |                       |
|--------|-----------------------|
| 1 each | 3" Aluminum Gland     |
| 1 each | 3" Gland "O" Ring     |
| 1 each | 3" Backup Ring        |
| 1 each | 1 1/2" U-Cup Rod Seal |
| 1 each | 1 1/2" Rod Wiper      |
| 1 each | 1" Locknut            |

### **KIT NO. 663340:**

Complete assembled 3" Cylinder Piston with all seals. Consists of:

|        |                      |
|--------|----------------------|
| 1 each | 3" Aluminum Piston   |
| 2 each | 2" U-Cup Piston Seal |
| 1 each | 1" Rod "O" Ring      |
| 1 each | 1" Locknut           |

### **KIT NO. 662053:**

All seals needed to service one (1) 3" Cylinder Gland. Consists of:

|        |                       |
|--------|-----------------------|
| 1 each | 3" Gland "O" Ring     |
| 1 each | 3" Backup Ring        |
| 1 each | 1 1/2" U-Cup Rod Seal |
| 1 each | 1 1/2" Rod Wiper      |
| 1 each | 1" Locknut            |

### **KIT NO. 662056:**

All seals needed to service one (1) 3" Cylinder Piston. Consists of:

|        |                      |
|--------|----------------------|
| 2 each | 3" U-Cup Piston Seal |
| 1 each | 1" Rod "O" Ring      |
| 1 each | 1" Locknut           |

- Parts available in kit only.

## HYDRAULIC CYLINDER PARTS SCHEDULE

### 3" CYLINDER PARTS LIST:

#### BUCKET CYLINDER (Part No. 672451):

| Key    | Part No.    | Description           | Quantity |
|--------|-------------|-----------------------|----------|
| 1..... | 672452..... | Tube Weldment .....   | 1        |
| 2..... | 661017..... | Locknut .....         | 1        |
| 3..... | 651537..... | Piston Assembly ..... | 1        |
| 4..... | 640301..... | "O" Ring Seal.....    | 1        |
| 5..... | 651565..... | Gland Assembly.....   | 1        |
| 6..... | 658275..... | Rod Weldment .....    | 1        |
|        | 662049..... | Seal Kit.....         | 1        |

# HYDRAULIC CYLINDER PARTS DIAGRAM

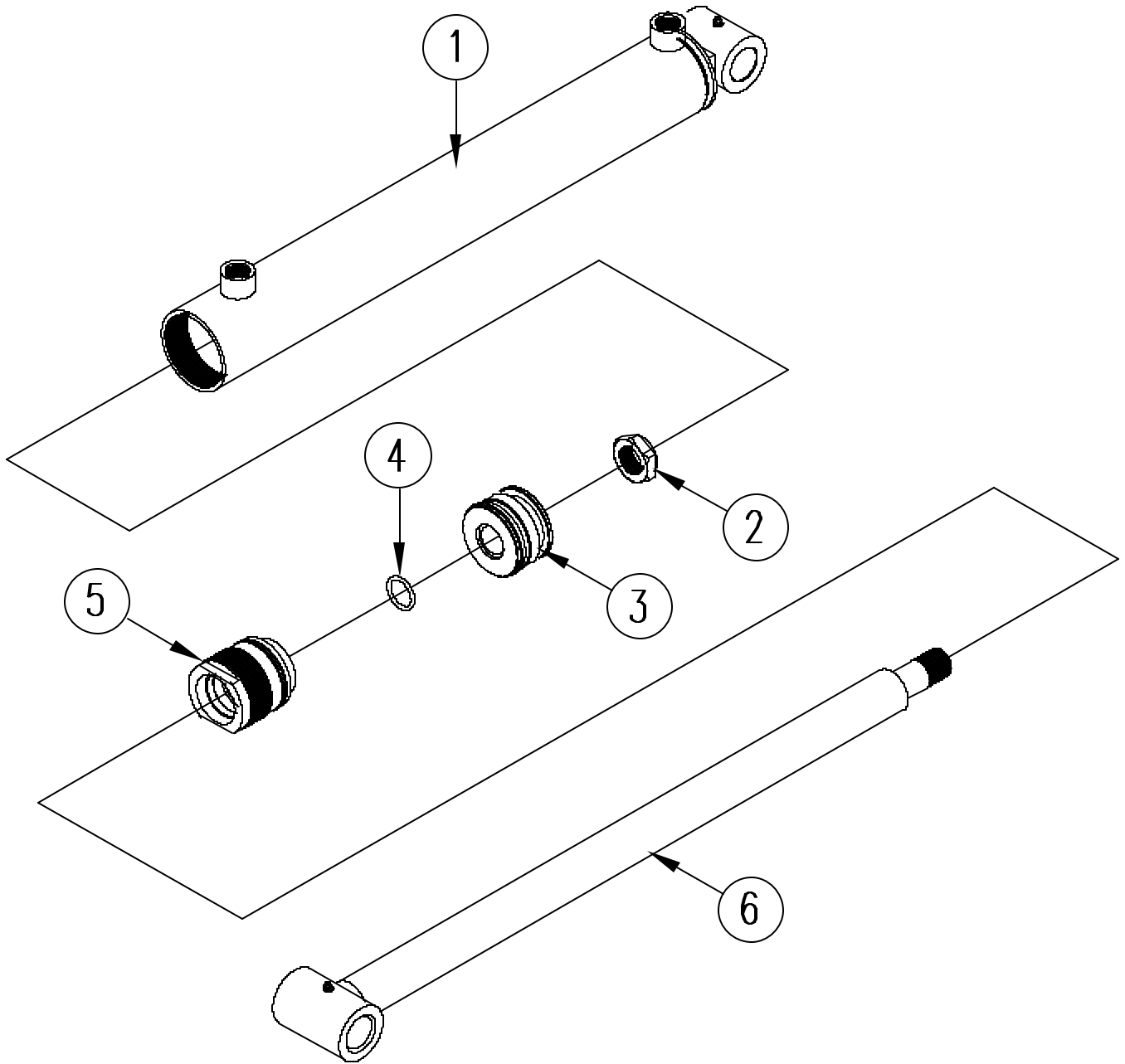

# CYLINDER GLAND SERVICE DIAGRAM

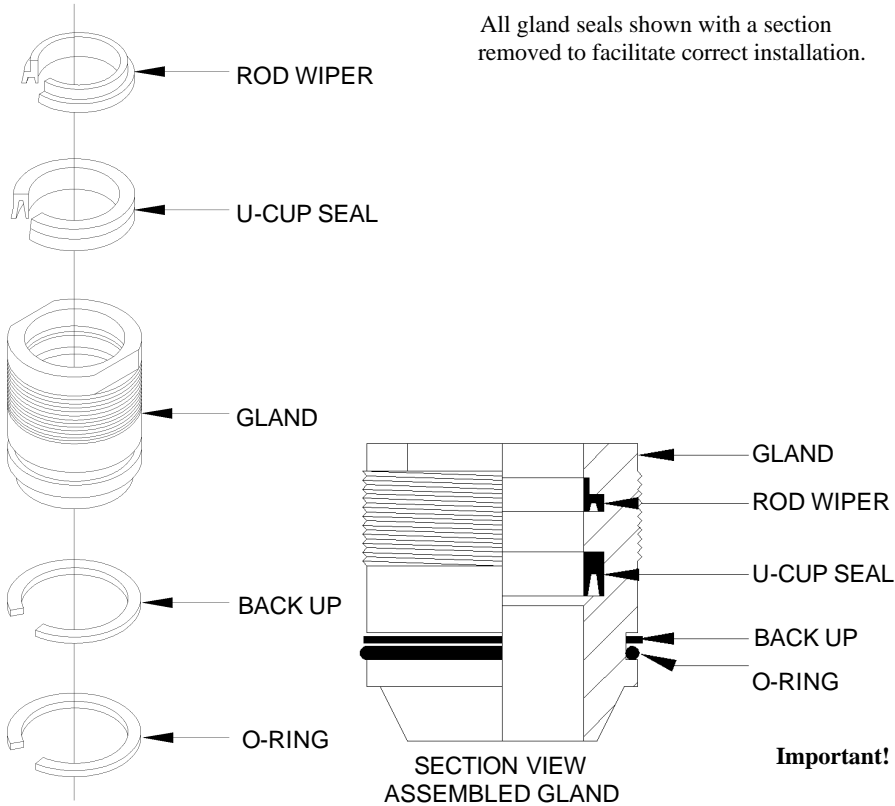

All gland seals shown with a section removed to facilitate correct installation.

Note: To install rod wiper and U-cup seal, fold similar to shape shown below, slip into gland bore and locate each in its respective groove. Tools are used to fold seals, take care not to damage sealing surfaces.



**Important!** Be sure all gland and piston seals have been installed correctly before cylinder is assembled!

# CYLINDER PISTON SERVICE DIAGRAM

## To Remove Seals:

Carefully cut across each seal with a sharp knife. Be sure not to scratch sealing surfaces of aluminum piston. If a sharp knife is not available. An electric soldering gun or hot iron may be used to melt throughout seals.

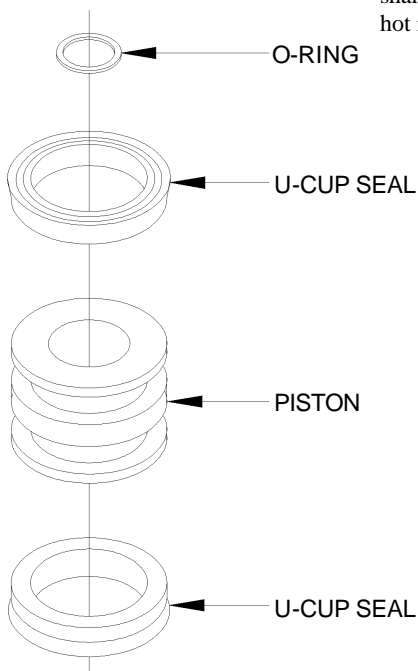

## To Install Seals:

1. Thoroughly clean piston sealing surface of all foreign matter.
2. Heat new seals in hydraulic oil to 160° F. Never use a direct flame or heated water on hydraulic seals.
3. Remove seals from oil, wipe dry and install in piston grooves as shown in illustration at left. Be sure seals have completely seated in piston grooves before allowed to cool.
4. Replace piston on cylinder shaft and assemble cylinder when seals have cooled to room temperature.

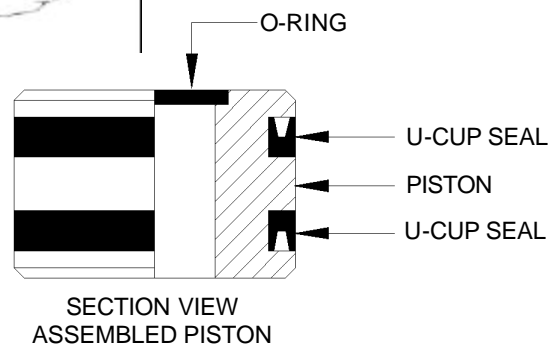

## **LIMITED WARRANTY**

Thank you for purchasing a quality product from Koyker Manufacturing Company (Koyker). Your satisfaction with Koyker's products is very important to us. This manual will help you understand the function, service intervals, and warranty of your new Koyker product(s). It is the retail customer's responsibility to inspect the Koyker product(s) or part(s) before using. Before operating or allowing anyone to operate a Koyker product, please take time to read the manual thoroughly. Failure to do so may result in injury or death and is considered misuse. If your manual has been lost or destroyed, please contact Koyker at (800) 456-1107 or (605) 647-2811 for a new copy.

### **Koyker Manufacturing Company** **Limited Warranty**

Koyker warrants to the retail customer of any new Koyker product, purchased from an authorized Koyker dealer, that the product manufactured by Koyker is free from defects in material and workmanship. This warranty is limited to one (1) year from the date of retail sale to the retail customer for all non-commercial, state, county, or city use. A six (6) month period from the date of retail sale to the retail customer is warranted for all commercial use.

Koyker reserves the right to inspect any products or parts which are claimed to be defective, have defective material, or have less than satisfactory workmanship before Koyker repairs or replaces any products or parts. A retail customer must notify Koyker of a claim by registered or certified mail, return receipt requested, within 30 days after discovery of a problem, or the claim shall be deemed waived. Defective products or parts must be returned to the Koyker factory, at the customer's expense, for inspection by Koyker. Koyker's obligation is limited to repairing or replacing, at its factory, any part or component it determines is defective. Koyker's replacement parts are manufactured with the same precision and skill as its original equipment. All warranted or replacement parts purchased or provided by Koyker will have, at a minimum, a 90-day warranty from the date of installation. If the expiration of the original warranty on a new Koyker product is longer than 90 days, the warranted parts will be covered until the original, new product warranty expiration date.

All cylinder claims shall be handled through Koyker's dealers or distributors. All hydraulic cylinders are thoroughly inspected before shipment from the Koyker factory. Therefore, no claim may be granted where a cylinder has been damaged or abused (including, but not limited to, bent tubes, dents, nicks, abused threads, attempted alterations, or welding), or unless the claim is made to Koyker within one (1) year from the sale to the original purchaser.

Any defective cylinder reported to Koyker within one (1) year from the sale by the dealer to the original purchaser may be repaired or replaced after Koyker's inspection and approval. In such case, notify a Koyker dealer for proper instructions. If after inspection, Koyker finds that the cylinder is not defective and has been abused or otherwise damaged, any transportation charges shall be paid by the original purchaser immediately after receiving notification of Koyker's inspection results.

## LIMITED WARRANTY

Cylinders requiring factory repair more than one (1) year after sale to an original purchaser shall be given to a Koyker dealer for return to Koyker with transportation charges prepaid by the purchaser. The purchaser shall be responsible for all service and repair charges. Leaks around the shaft seal and internal bypass leaks may be field repaired. Service kits are available for those repairs.

### Warranty Limitations and Exclusions.

**THE WARRANTIES SET FORTH ABOVE ARE EXCLUSIVE AND ARE IN LIEU OF, AND PURCHASER HEREBY WAIVES, ALL OTHER CONDITIONS, REPRESENTATIONS AND WARRANTIES, EXPRESS OR IMPLIED BY STATUTE, USAGE, CUSTOM OF TRADE OR OTHERWISE, INCLUDING, WITHOUT LIMITATION, THE IMPLIED WARRANTIES OF MERCHANTABILITY AND FITNESS FOR A 2 PARTICULAR PURPOSE. NOTWITHSTANDING ANY OTHER OR PRIOR STATEMENT, WRITTEN OR ORAL, KOYKER MAKES NO OTHER WARRANTIES REGARDING THE QUALITY OF THE PRODUCTS OR THE MATERIALS CONTEMPLATED HEREUNDER.**

No warranty is given by Koyker for parts, components, or trade accessories furnished by Koyker but not manufactured by it. Those items are covered by the warranty of their manufacturer, if any. No person, firm, or corporation, including the selling dealer, is authorized to assume for Koyker any other liability in connection with the sale of these goods.

**KOYKER SHALL NOT BE LIABLE FOR INDIRECT, SPECIAL, INCIDENTAL, CONSEQUENTIAL OR PUNITIVE DAMAGES DIRECTLY OR INDIRECTLY ARISING FROM THE DESIGN, CONSTRUCTION, INSTALLATION, MANUFACTURE, OR USE OF KOYKER'S PRODUCTS, PARTS, COMPONENTS, OR TRADE ACCESSORIES.** Such incidental and consequential damages shall include, but not be limited to: non-associated taxes or duties; charges for normal maintenance or service; loss of crops, property damage, or any other income loss; freight charges, other than normal freight charges associated with Koyker products or parts; other installation charges not approved by Koyker; rental charges of any substitute equipment; expenses due to lost, damaged, or delayed products or parts resulting from acts beyond the control of Koyker; and personal injury or death of operator or bystanders by misappropriated use of Koyker products or parts.

A user shall notify Koyker in writing within 30 days of any accident or occurrence involving Koyker products resulting in personal injury or property damage and shall cooperate fully with Koyker in investigating and determining the cause of such accident or occurrence. In the event that a user fails to give such notice to Koyker and so cooperate, such user agrees to indemnify and hold Koyker harmless from all loss or damage arising from such accident or occurrence.

## LIMITED WARRANTY

Among other conditions, Koyker's warranty will not apply:

1. Products or parts that are subject to misuse, abuse, and/or negligence.
2. For surface wear, scheduled maintenance parts, and other items that Koyker deems expendable.
3. If products or parts not manufactured by Koyker or approved by Koyker are connected to or used in conjunction with the Koyker products or parts and if Koyker deems the non-Koyker products or parts affect the performance, safety, reliability, or life of the Koyker products or parts.
4. If products or parts sold by, but not manufactured by Koyker, have their own vendor warranties.

Koyker reserves the right to implement new designs for the continual improvement of their products. These product improvements will be ongoing, and Koyker will not be responsible for incurring cost or obligation for installations or upgrades to previously sold products.

No employee or representative of Koyker may change or amend any part of this limited warranty or make exceptions to this limited warranty, unless such changes are made in writing by Koyker's legal counsel.

**All goods being returned to the Koyker factory must have a Returned Goods Authorization (RGA) number from Koyker. To obtain an RGA number, call (800) 456-1107 or e-mail Koyker at [koyker@koykermfg.com](mailto:koyker@koykermfg.com).**

**Returned parts will not be accepted without an RGA number written on the outside of the box of the returned goods. 30 days are allowed for shipping, from the day the RGA number was issued by Koyker. If the return item(s) is not received into the Koyker system within 30 days, no credit will be issued. Upon request only, a second RGA number will be issued and an additional 30 days may be allowed. No credit will be issued if the return item(s) are not received into the Koyker system 30 days after the second RGA number was issued.**

Should you require additional information or assistance, please contact Koyker Manufacturing Company at (800) 456-1107, (605) 647-2811, or e-mail Koyker at [koyker@koykermfg.com](mailto:koyker@koykermfg.com).